

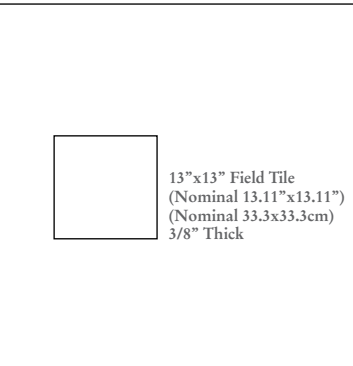

Somerset™ Beige 16"x16"

## AVAILABLE SIZES

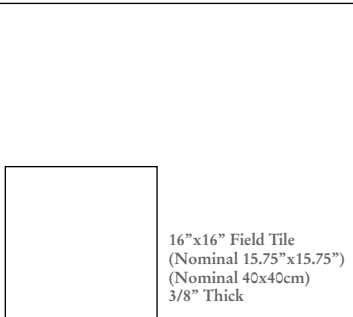

## SUGGESTED PATTERNS

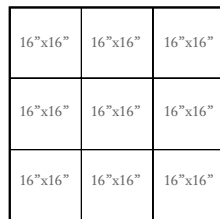

Grid

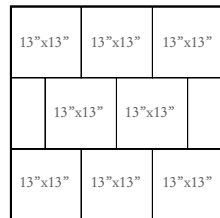

Offset

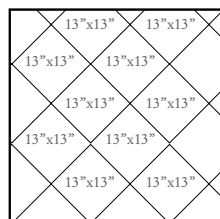

Diamond

## COLOR SHADE VARIATION



Variations in color, shade, and texture are inherent in ceramic tile. Several pieces should be examined collectively prior to installation.

Grout Joint Recommendation: Approximately 3/16"

## APPLICATION

Appropriate for interior and exterior floors and walls in non-freezing temperatures. Ceramic tile floors, like other types of glazed floors, can become slippery when wet. Take extra care when selecting a floor product that will be exposed to conditions such as liquids, grease, or oil. Always follow proper installation methods.

## TECHNICAL SPECIFICATIONS

| TEST NAME               | ASTM TEST   | TEST RESULTS                       |
|-------------------------|-------------|------------------------------------|
| Abrasion Resistance     | ASTM C-1027 | IV                                 |
| Breaking Strength       | ASTM C-648  | 205 lbs.                           |
| Chemical Resistance     | ASTM C-650  | Resistant                          |
| Coefficient of Friction | ASTM C-1028 | Dry Neolite .83<br>Wet Neolite .47 |
| Frost Resistance        | ASTM C-1026 | Not Resistant                      |
| Scratch Hardness        | MOHS SCALE  | 9                                  |
| Water Absorption        | ASTM C-373  | 9.40%                              |

Marble's classic look is achieved in glazed ceramic with Somerset™. The series' subtle color palette beautifully complements any setting. Available in two colors – Beige and Cream – as well as two versatile sizes 13"x13" and 16"x16".



Beige 16" x16"

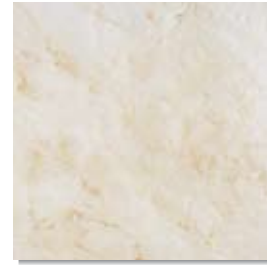

Beige 13" x13"



Cream 16" x16"

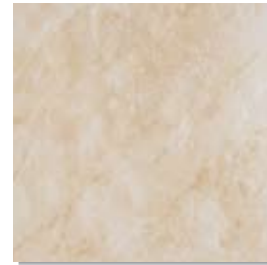

Cream 13" x13"

COORDINATING DECORATIVE ACCENT IDEAS



Ancora Listello  
4" x12"



Como Listello  
4" x12"

TRIM



Floor SBN 3"x 13"